

Clamps to DIN 3015

DIN 3015-1 Light range

DIN 3015-2 Heavy range

DIN 3015-3 Twin clamps

General

Clamps to DIN 3015 are a sophisticated modular system for fixing pipes with static and dynamic loads.

It offers several advantages:

- Damping of shocks, vibrations and noise, as well as compensation of pipe tolerances through the use of elastomer inserts
- High strength ensured by ribbed clamp bodies
- Weld plate from a single pulled piece
- Steel parts with sufficient surface protection
- Secure overhead installation through clamping effect of the plastic parts
- Can be installed on C mounting rails, also available with weld struts
- Efficient plug/screw installation of the mounting rail nuts
- Optional:
 - Elimination of rust penetration due to all-round anti-corrosion coatings
 - Gentle component mounting with clamp bodies made of a thermoplastic element

Assembly

All the pipe clamps in the HY-ROS range offer extremely impressive features: excellent resilience, optimal material resistance to tensile and tear stress, and high abrasion resistance.

The type of pipe clamp, size and material are selected depending on the application and type of stress (thermal / mechanical).

- For secure mounting, stable carrier units, such as base plates and mounting rails, are required according to the load requirements.
- The first clamp should be mounted directly after the threaded connection. This protects the connection from vibrations.
- Bends in the pipe should be clamped on both sides of the bend (pulsation direction must be taken into account).
- The prescribed material property limits must be observed.
- In the absence of any past experience, the recommended distance between pipe supports must be adhered to (see right).
- If valves are incorporated in the pipelines, it is recommended that support is provided in front of and behind these valves.

Recommended distance between pipe supports

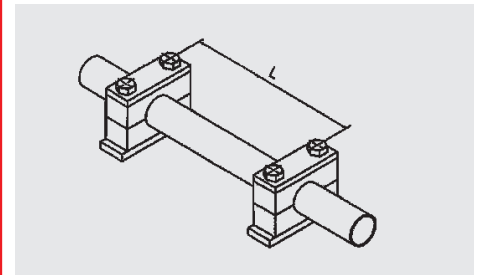

Distance between pipe supports L [m]	Pipe diameter D	
	min [mm]	max [mm]
1.0	6.0	12.7
1.2	12.7	22.0
1.5	22.0	32.0
2.0	32.0	38.0
2.7	38.0	57.0
3.0	57.0	75.0
3.5	75.0	76.1
3.7	76.1	88.9
4.0	88.9	102.0
4.5	102.0	114.0
5.0	114.0	168.0
6.0	168.0	219.0
6.7	219.0	324.0
7.0	324.0	356.0

Material properties of clamps to DIN 3015

Material	Density	Yield stress and/or tensile strength	Shore hardness	Temperature resistance	Fire protection
	ISO 1183	ISO 527-2	ISO 868		EN 45545-2
Polypropylene (PP)	0.9 g/cm ³	26 MPa	-	-30 to +90 °C	-
Polyamide (PA)	1.13 g/cm ³	tr. 90 / lf. 45 MPa	-	-40 to +120 °C	-
Polyamide, flame-retardant (PAFF)	1.14 g/cm ³	tr. 80 / lf. 40 MPa	-	-40 to +120 °C	R22, R23 / HL1, HL3, HL3
Thermoplastic elastomer (TPE)	0.97 g/cm ³	8.3 MPa	73 ±5° Shore A Others on request	-40 to +125 °C	-
Acrylonitrile butadiene elastomer (NBR)	1.35 g/cm ³	25 MPa	73 ±5° Shore A Others on request	-35 to +90 °C	-

Bolt torque rating to DIN 3015 Part 10

Standard	Thread	Nominal size	Torque rating [Nm] with clamp material		
			PP	PA	AL
Light range	M 6	0 to 6	8	10	12
Heavy range	M 10	1 to 2	12	20	30
		3	15	25	35
	M 12	4	30	40	55
	M 16	5	45	55	120
	M 20	6	80	150	220
	M 24	7	110	200	250
		8	180	350	500
		9	200	370	500
M 30	10	270	470	600	
	M 6	1	5	6	-
		M 8	2 to 4	12	12
	5		8	8	-

Note: The specified bolt torque ratings relate to assembly with cover plates and hex. head bolts to ISO 4014 / 4017.

Packing details for light range DIN 3015 Part 1

Light range	Pairs of clamp jaws			Weld and cover plates			Bolts	
	Box (pairs)		Bag (pairs)	Box (pieces)		Bag (pieces)	Box (pieces)	Bag (pieces)
	PP, PA	AL		AP	DP			
0	1000	-	50	250	500	50	1000	50
1	1000	500	50	250	500	50	1000	50
2	1000	250	50	250	250	50	1000	50
3	500	250	50	250	250	50	1000	50
4	500	200	25	200	200	25	1000	50
5	250	100	25	100	200	25	500	50
6	250	100	25	100	200	25	500	50
TMV 6 / TM6				1000		50		
Washer				-		50		
Build-up bolt the same as normal bolts								

Packing details for heavy range DIN 3015 Part 2

Heavy range	Pairs of clamp jaws			Weld and cover plates		Bolts	
	Box (pairs)		Bag (pairs)	Box (pieces)	Bag (pieces)	Box (pieces)	Bag (pieces)
	PP, PA	AL					
1	500	250	25	100	25	250	50
2	250	150	25	100	25	250	50
3	250	100	25	100	25	250	50
4	250 (pieces)	-	-	25 (AP), 50 (DP)	-	100	-
5	120 (pieces)	-	-	25	-	25	-
TM 10				250	50		
TM 12				250	50		
Washer				-	50		
Build-up nut size 1 - 4				250	50		
Build-up nut size 5				100	-		
Stud size 1 - 3				250	50		
Stud size 4				250	-		
Stud size 5				100	-		

Packing details for twin clamps DIN 3015 Part 3

Twin clamp	Pairs of clamp jaws		Weld and cover plates			Bolts		
	Box (pairs)		Bag (pairs)	Box (pieces)		Bag (pieces)	Box (pieces)	Bag (pieces)
	PP, PA	AL		AP	DP			
1	1000		50	200	250	50	500	50
2	750		50	100	200	50	500	50
3	500		50	100	200	50	500	50
4	250		25	100	100	25	200	25
5	250		25	100	100	25	200	25
TMV 6 / TM6						50		
TM 8						25		
Build-up bolt the same as normal bolts								

Note: Only available in given pack sizes

Comparison metrical / imperial measurements

Pipe outside Ø [mm]	Inches	Nominal bore
6	-	-
6.4	1/4	-
8	5/16	-
9.5	3/8	-
10	-	G 1/8
12	-	-
12.7	1/2	-
13.7	-	G 3/4
14	-	-
15	-	-
16	5/8	-
17.1	-	G 3/8
18	-	-
19	3/4	-
20	-	-
21.3	-	G 1/2
22	-	-
23	-	-
25	-	-
25.4	1	-
26.9	-	G 3/4
28	-	-

Pipe outside Ø [mm]	Inches	Nominal bore
30	-	-
32	1 1/4	-
33.7	-	G 1
35	-	-
38	1 1/2	G 1 1/8
40	-	-
42	-	G 1 1/4
44.5	1 3/4	-
48.3	-	G 1 1/2
50.8	2	-
54	-	-
57	2 1/4	-
60.3	-	G 2
63.5	2 1/2	-
65	-	-
70	-	-
73	-	-
76.1	3	G 2 1/2

Pipe outside Ø [mm]	Inches	Nominal bore
80	-	-
88.9	3 1/2	G 3
90	-	-
96	-	-
101.6	4	G 3 1/2
108	4 1/4	-
114.3	4 1/2	G 4
136	-	-
139.7	5 1/2	G 5
168	6 1/2	G 6
177.8	7	-
193.7	7 5/8	G 7
219.1	8 5/8	G 8
244.5	-	-
273	-	G 10
323.9	12 3/4	G 12
355.6	-	G 14
406.4	-	G 16

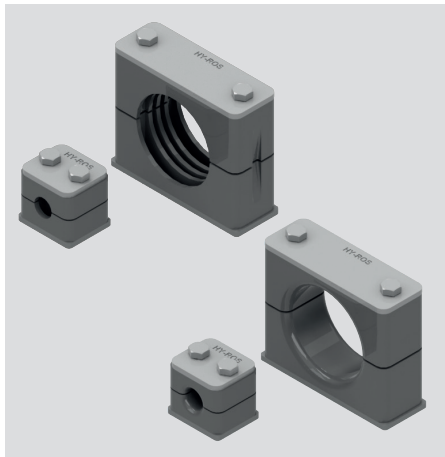

Light range to DIN 3015 Part 1

HRL, HRGL

Size	Pipe outside Ø [mm]
0	6.4
	8
	9.5
	10
	12
1	6
	6.4
	8
	9.5
	10
2	12
	12.7
	13.7
	14
	15
3	16
	17.1
	18
	19
	20
4	21.3
	22
	23
	25
	25.4
5	26.9
	28
	30
	32
	33.7
6	35
	38
	40
	42
	44.5
7	48.3
	50.8
	57.2
	60.3
	63.5
8	70.0
	73.0
	76.1
	88.9
	101.6

Model code

(also order example)

HRL 2 A 16 PP ST M BL

Range

HRL = HY-ROS clamp, light range with ribbed internal surface
 HRGL = HY-ROS clamp, light range with smooth internal surface

Size

0 = size 0
 1 = size 1
 2 = size 2
 up to size 8

Model for complete clamps

(pair of clamp jaws not mentioned)

A = with weld plate, cover plate and hex. head bolt
 AV = with extended weld plate, cover plate and hex. head bolt
 A1 = with cover plate and hex. head bolt
 A1TM = with cover plate, hex. head bolt and mounting rail nut
 B = with weld plate, hex. socket bolt and washer
 BV = with extended weld plate, hex. socket bolt and washer
 B1 = with hex. socket bolt and washer
 B1TM = with hex. socket bolt, washer and mounting rail nut
 C = with weld plate, slotted-head bolt and washer
 CV = with extended weld plate, slotted-head bolt and washer
 C1 = with slotted-head bolt and washer
 C1TM = with slotted-head bolt, washer and mounting rail nut
 D = with build-up bolt and locking plate

Pipe diameter

Material of clamp jaws

PP = polypropylene
 PA = polyamide
 PAFF = polyamide, flame-retardant to EN 45545-2 R22, R23, HL3
 TPE = thermoplastic elastomer
 AL = aluminium (sizes 0, 7, 8 on request)

Material of steel parts

ST = steel
 A2 = stainless steel (on request)
 A4 = stainless steel (on request)



Thread type

M = metric thread

Plating of steel parts

BL = weld plate unplated, cover plate zinc-plated, bolts zinc-plated
 ZN = weld plate zinc-plated, cover plate zinc-plated, bolts zinc-plated
 Others on request

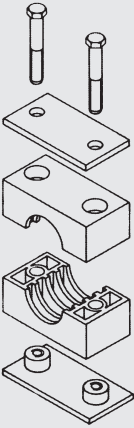
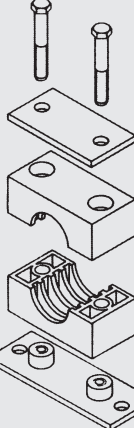
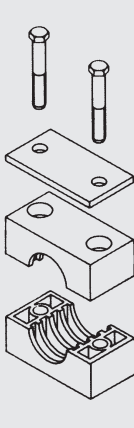
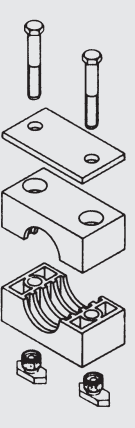
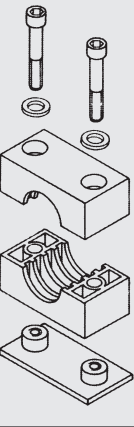
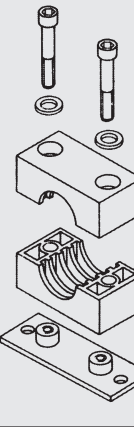
Models for light range DIN 3015 Part 1

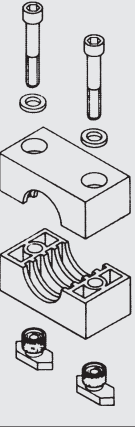
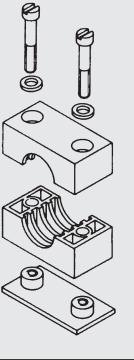
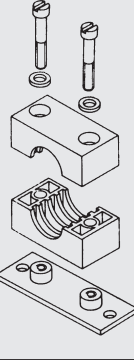
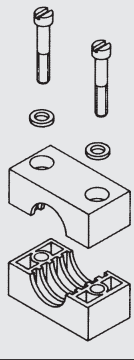
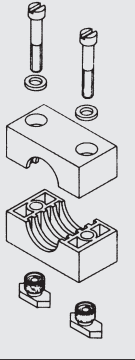
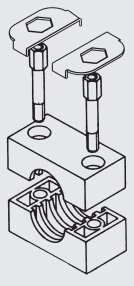
<p>Model A Size 0–8</p> 	<p>Model AV Size 0–8</p> 	<p>Model A1 Size 0–8</p> 	<p>Model A1TM Size 0–8</p> 
<p>Model B Size 0–8</p> 	<p>Model BV Size 0–8</p> 	<p>Model B1 Size 0–8</p> 	<p>Model B1TM Size 0–8</p> 
<p>Model C Size 0 - 6</p> 	<p>Model CV Size 0 - 6</p> 	<p>Model C1 Size 0 - 6</p> 	<p>Model C1TM Size 0 - 6</p> 
<p>Model D Size 0 - 6</p> 	<p>Note: No washers are required in the AL version for series B and C.</p>		

Dimensions for light range DIN 3015 Part 1

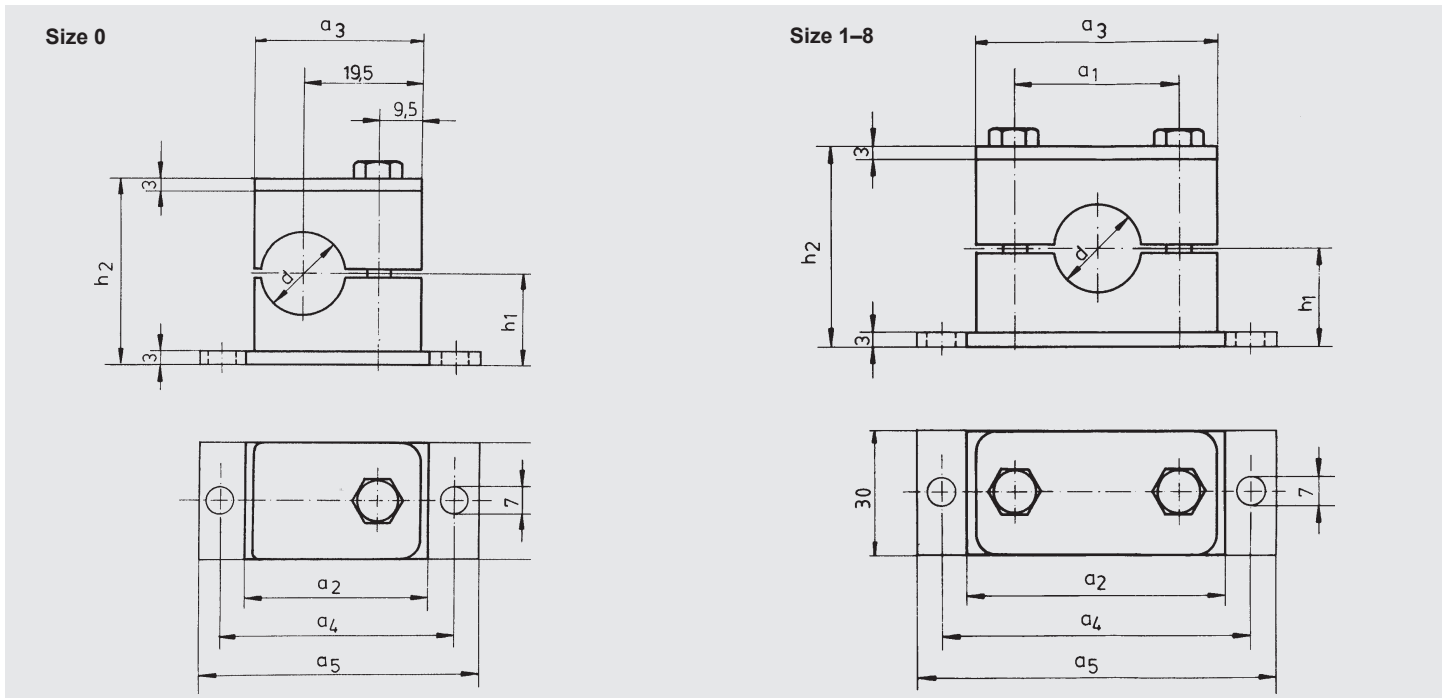

Size	Dimensions [mm]							Hex. head	Hex. socket	Stud	Slotted head
	a1	a2	a3	a4	a5	h1	h2	ISO 4014	ISO 4762	DIN 938	ISO 1207
0	-	30	28	44	58	16	32	M6 x 30	M6 x 20	M6 x 20	M6 x 20
1	20	36	36	50	64	16	32	M6 x 30	M6 x 20	M6 x 20	M6 x 20
2	26	42	40	56	70	19.5	39	M6 x 35	M6 x 25	M6 x 25	M6 x 25
3	33	50	48	64	78	20.5	41	M6 x 40	M6 x 30	M6 x 30	M6 x 30
4	40	60	57	73	87	24	48	M6 x 45	M6 x 35	M6 x 35	M6 x 35
5	52	72	70	86	100	32	64	M6 x 60	M6 x 50	M6 x 50	M6 x 50
6	66	88	86	100	116	36	72	M6 x 70	M6 x 60	M6 x 60	M6 x 60
7	94	122	121	136	150	51.5	103	M6 x 100	M6 x 85	-	-
8	120	148	147	162	178	64	128	M6 x 125	M6 x 110	-	-

NOTE: For sizes 7 and 8, the cover plate and weld plate are 5 mm thick.

Individual parts for light range DIN 3015 Part 1

Pair of clamp jaws, ribbed (HRL...KP...)

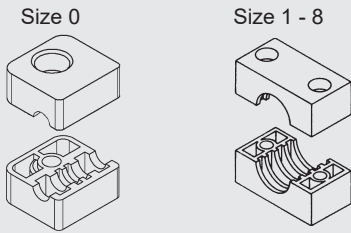

Pair of clamp jaws, smooth (HRL...KP...)

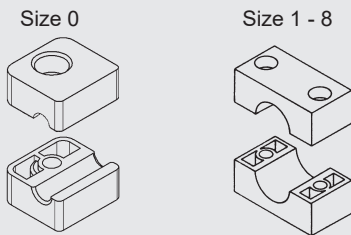

Model code (also order example)

HRL 3 KP 23 PP

Range

HRL = HY-ROS clamp, light range with ribbed internal surface
 HRGL = HY-ROS clamp, light range with smooth internal surface

Size

(as per dimensions)

Designation

KP = pair of clamp jaws

Pipe diameter

Material of clamp jaws

PP = polypropylene
 PA = polyamide
 PAFF = polyamide, flame-retardant to EN 45545-2 R22, R23, HL3
 TPE = thermoplastic elastomer
 AL = aluminium (sizes 0, 7, 8 on request)

Cover plate (DP)

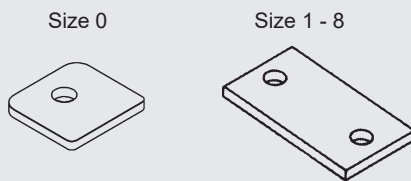

Model code (also order example)

HRL 3 DP ST ZN

Range

HRL = HY-ROS light range

Size

(as per dimensions)

Designation

DP = cover plate

Material of steel parts

ST = steel
 A2 = stainless steel (on request)
 A4 = stainless steel (on request)

Plating of steel parts

BL = unplated
 Others on request

Weld plate (AP)

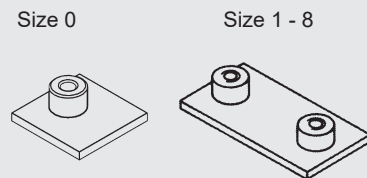

Extended weld plate (APV)

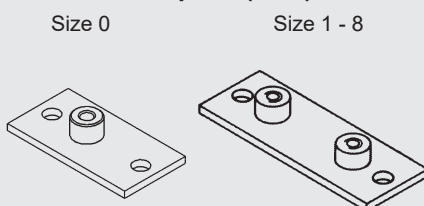

Model code (also order example)

HRL 2 AP ST M BL

Range

HRL = HY-ROS light range

Size

(as per dimensions)

Designation

AP = weld plate
 APV = extended weld plate

Material of steel parts

ST = steel
 A2 = stainless steel (on request)
 A4 = stainless steel (on request)

Thread type

M = metric thread

Plating of steel parts

BL = unplated
 Others on request

Interconnecting weld plate (RAP)

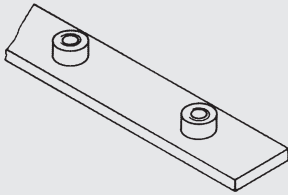

Dimensions

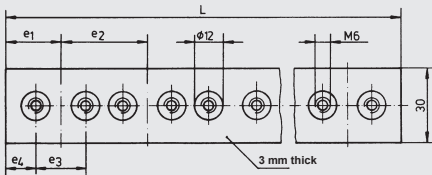

Model code

(also order example)

HRL 2a RAP ST M BL

Range

HRL = HY-ROS light range

Size

(as per dimensions)

Designation

RAP = interconnecting weld plate

Material of steel parts

ST = steel

A2 = stainless steel (on request)

A4 = stainless steel (on request)

Thread type

M = metric thread

Plating of steel parts

BL = unplated

Others on request

Size	Number of clamps	Dimensions [mm]				
		e1	e2	e3	e4	L
0	10	-	30	-	-	298
1b	10	17	40	20	7	394
2a	10	20	43	26	7	427
2b	10	20	52	26	7	508
3a	10	24	52	33	7.5	516
3b	10	24	75	33	7.5	723
4	5	28.5	60	40	8.5	297
5	5	35	75	52	9	370
6	5	43	90	66	10	446

Double weld plate (DAP)

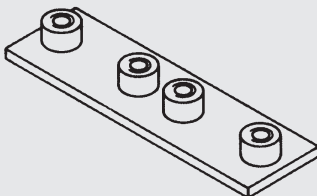

Dimensions

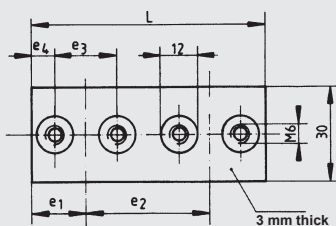

Model code

(also order example)

HRL 2a DAP ST M BL

Range

HRL = HY-ROS light range

Size

(as per dimensions)

Designation

DAP = double weld plate

Material of steel parts

ST = steel

A2 = stainless steel (on request)

A4 = stainless steel (on request)

Thread type

M = metric thread

Plating of steel parts

BL = unplated

Others on request

Size	Number of clamps	Dimensions [mm]				
		e1	e2	e3	e4	L
0	2	-	-	30	9.5	63
1b	2	18	40	20	8	75
2a	2	21.5	43	26	8.5	86
2b	2	21	52	26	8	94
3a	2	26	52	33	9.5	104
3b	2	25	75	33	8.5	125
4	2	28.5	60	40	8.5	117
5	2	35	75	52	9	145
6	2	43	90	66	10	176

Bolts

Hex. head bolt ISO 4014



Hex. socket cap bolt ISO 4762



Slotted-head bolt ISO 1207



Model code

(also order example)

6kt-shr.ISO4014 - M6 x 30 - 8.8 A3B

Range

6kt-shr.ISO4014 = hex. head bolt to ISO 4014
 Zyl-shr.ISO4762 = hex. socket bolt to ISO 4762
 Zyl-shr.ISO1207 = slotted-head bolt to ISO 1207

Size

ISO4014	ISO4762	ISO1207	for HRL size
M6 x 30	M6 x 20	M6 x 20	0+1
M6 x 35	M6 x 25	M6 x 25	2
M6 x 40	M6 x 30	M6 x 30	3
M6 x 45	M6 x 35	M6 x 35	4
M6 x 60	M6 x 50	M6 x 50	5
M6 x 70	M6 x 60	M6 x 60	6
M6 x 100	M6 x 85	-	7
M6 x 125	M6 x 110	-	8

Bolt quality

8.8 = to ISO 4014, ISO 4762
 4.6 = to ISO 1207

Bolt plating

A3B = zinc-plated
 Others on request

Build-up bolt (AF)

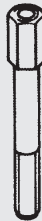

Dimensions

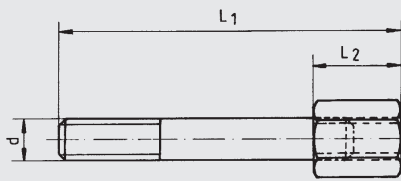

Size	Dimensions [mm]		
	L1	L2	L3
0+1	34	14	M6
2	39	14	M6
3	44	14	M6
4	49	14	M6
5	64	14	M6
6	74	14	M6

NOTE: Size 7 + 8 on request

Model code

(also order example)

HRL 4 AF ST M ZN

Range

HRL = HY-ROS light range

Size

(as per dimensions)

Designation

AF = build-up bolt

Material of steel parts

ST = steel
 A2 = stainless steel (on request)
 A4 = stainless steel (on request)

Thread type

M = metric thread

Plating of steel parts

ZN = zinc-plated
 Others on request

Locking plate (SIP)



Dimensions (for all sizes)

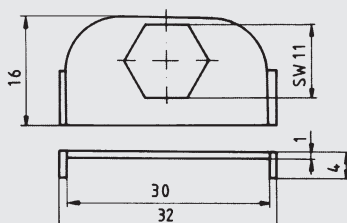

Model code

(also order example)

HRL 0 SIP ST ZN

Range

HRL = HY-ROS light range

Size

0 = for all sizes

Designation

SIP = locking plate

Material of steel parts

ST = steel
 A2 = stainless steel (on request)
 A4 = stainless steel (on request)

Plating of steel parts

ZN = zinc-plated
 Others on request

C mounting rail (TS)

C mounting rail TS

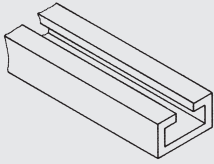

C mounting rail with weld struts
TS28x11AS

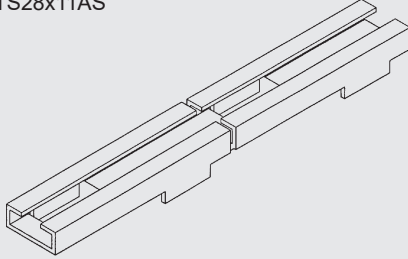

Dimensions

C mounting rail TS
available in 1 m and 2 m pieces

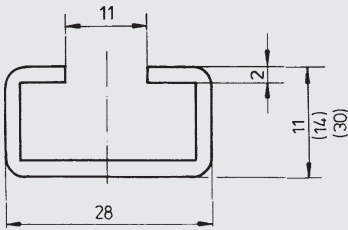

C mounting rail with weld struts
available in 1 m pieces

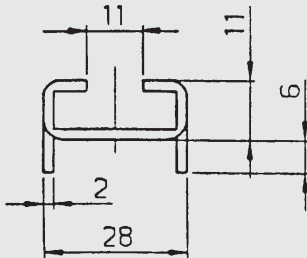

Mounting rail nut (TM)

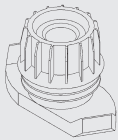

Dimensions

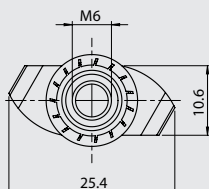
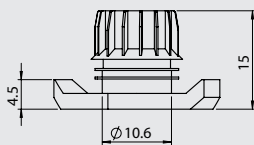

Model code

(also order example)

HRL TS28x11 ST BL 1m

Range

HRL = HY-ROS light range

Model

TS28x11 = C mounting rail 28x11
 TS28x14 = C mounting rail 28x14
 TS28x30 = C mounting rail 28x30
 TS28x11AS = C mounting rail with weld struts 28x11

Material of steel parts

ST = steel
 AL = aluminium (on request)
 A2 = stainless steel (on request)
 A4 = stainless steel (on request)

Plating of steel parts

BL = unplated
 ZN = zinc-plated
 Others on request

Length

1 m
 2 m (not for C mounting rail with weld struts)
 Other lengths on request

Model code

(also order example)

HRL TMV6 ST ZN

Range

HRL = HY-ROS light range

Designation

TMV6 = mounting rail nut with anti-twist protection, size M6 (standard)
 TM6 = mounting rail nut without anti-twist protection, size M6

Material of steel parts

ST = steel
 A4 = stainless steel (on request)

Plating of steel parts

ZN = zinc-plated
 Others on request

NOTE

The information in this brochure relates to the operating conditions and applications described. For applications and operating conditions not described, please contact the relevant technical department.

The operator is always responsible for determining the product suitability for the specific application. Quantified values for product characteristics are average values for a new product that undergo a time deterioration process.

Subject to technical modifications and errors.

HYDAC Accessories GmbH

Hirschbachstr. 2

66280 Sulzbach/Saar

Tel.: +49 (0)6897 - 509-01

Fax: +49 (0)6897 - 509-1009

Internet: www.hydac.com

E-mail: accessories@hydac.com



Light range with elastomer insert to DIN 3015 Part 1

HREL, HRERL

Size	d internal surface smooth [mm]	d internal surface ribbed [mm]
4	6	-
	8	-
	10	10
	12	12
	12.7	-
	14	14
	15	15
	16	16
	17.2	17.2
	18	-
19	-	
6	20	20
	21.3	-
	22	22
	23	-
	25	25
	26.9	-
	28	28
	30	30
	32	-

Model A Size 4, 6

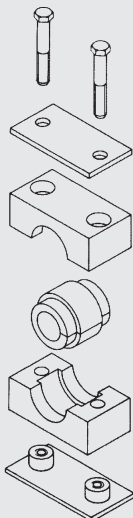

Model code (also order example)

HREL 4 A 16 PP ST M BL

Range

HREL = HY-ROS clamp, light range,
elastomer insert with smooth internal surface
HRERL = HY-ROS clamp, light range,
elastomer insert with ribbed internal surface

Size

4 = size 4
6 = size 6

Model for complete clamps

(pair of clamp jaws not mentioned)
A = with elastomer insert, weld plate,
cover plate and hex. head bolt

Pipe diameter

Material of clamp jaws

PP = polypropylene
PA = polyamide
PAFF = polyamide, flame-retardant to EN 45545-2 R22, R23, HL3

Material of steel parts

ST = steel
A2 = stainless steel (on request)
A4 = stainless steel (on request)

Thread type

M = metric thread

Plating of steel parts

BL = weld plate unplated, cover plate zinc-plated, bolts zinc-plated
Others on request

Dimensions

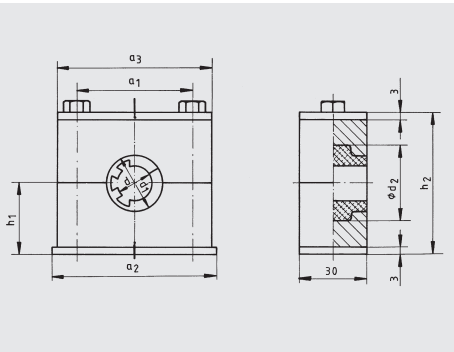

Individual parts

Pair of clamp jaws (KP) Size 4, 6

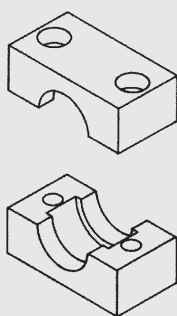

Elastomer insert smooth (HRES...EE...) Size 2/4L, 3/6L

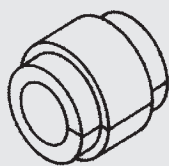

Elastomer insert ribbed (HRERS...EE...) Size 2/4L, 3/6L

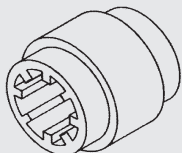

Size	Dimensions [mm]							Hex. head	Hex. socket	Stud	Slotted head
	d1	d2	a1	a2	a3	h1	h2	ISO 4014	ISO 4762	DIN 938	ISO 1207
4	25.5	31	40	59	57	23.5	47	M6 x 45	M6 x 35	M6 x 35	M6 x 35
6	39	46	66	88	86	35.5	71	M6 x 70	M6 x 60	M6 x 60	M6 x 60

Model code

(also order example)

HREL 4 KP PP

Range

HREL = HY-ROS clamp, light range, with elastomer insert

Size

4 = size 4
6 = size 6

Designation

KP = pair of clamp jaws

Material of clamp jaws

PP = polypropylene
PA = polyamide
PAFF = polyamide, flame-retardant to EN 45545-2 R22, R23, HL3

Model code

(also order example)

HRES 2/4L EE 16 TPE

Range

HRES = elastomer insert, internal surface smooth
HRERS = elastomer insert, internal surface ribbed

Size

2/4L = size 2 (HRS), size 4 (HRL)
3/6L = size 3 (HRS), size 6 (HRL)

Designation

EE = elastomer insert

Pipe diameter

(as per dimensions)

Insert material

TPE = thermoplastic elastomer

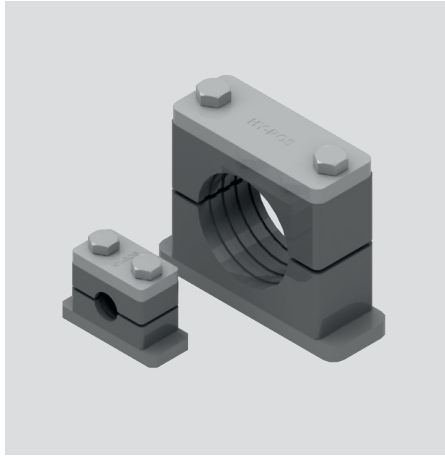

Heavy range to DIN 3015 Part 2

HRS, HRGS

Size	Pipe outside Ø [mm]	
1	6	13.7
	6.4	14
	8	15
	9.5	16
	10	17.1
	12	18
2	12.7	
	19	25.4
	20	26.9
	21.3	28
3	22	30
	25	
	25	35
	30	38
4	32	40
	33.7	42
	30	55
	38	57
	42	60.3
5	44.5	63.5
	48.3	65
	50.8	70
	38	76.1
6	65	80
	70	88.9
	73	
7	65	114.3
	96	127
	101.6	
	108	
8	90	
	136	
	139.7	
	168	
9	168	
	177.8	
	193.7	
	219.1	
10	219.1	
	244.5	
	273	
	323.9	
	355.6	
	406.4	

Model code

(also order example)

HRS 2 A 30 PP ST M BL

Range

HRS = HY-ROS clamp, heavy range with ribbed internal surface

HRGS = HY-ROS clamp, heavy range with smooth internal surface (on request)

Size

1 = size 1

2 = size 2

3 = size 3

up to size 10

Model for complete clamps

(pair of clamp jaws not mentioned)

A = with weld plate, cover plate and hex. head bolt

AV = with extended weld plate, cover plate and hex. head bolt

A1 = with cover plate and hex. head bolt

A1TM = with cover plate, hex. head bolt and mounting rail nut
(only up to size 4)

B = with weld plate, hex. socket bolt and washer
(only up to size 7)

D = with build-up bolt and locking plate
(only up to size 7)

G = with double weld plate, double cover plate and hex. head bolt

Pipe diameter

Material of clamp jaws

PP = polypropylene

PA = polyamide

PAFF = polyamide, flame-retardant to EN 45545-2 R22, R23, HL3

TPE = thermoplastic elastomer

AL = aluminium

Material of steel parts

ST = steel

A2 = stainless steel (on request)

A4 = stainless steel (on request)

Thread type

M = metric thread

Plating of steel parts

BL = weld plate unplated, cover plate zinc-plated, bolts unplated
(from size 8 cover plate unplated)

BL/ZN = weld plate unplated, cover plate zinc-plated, bolts zinc-plated

ZN = weld plate zinc-plated, cover plate zinc-plated, bolts zinc-plated

Models for heavy range DIN 3015 Part 2

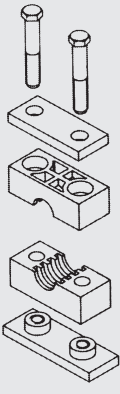
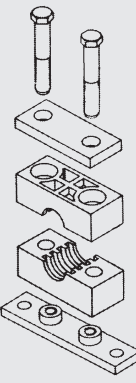
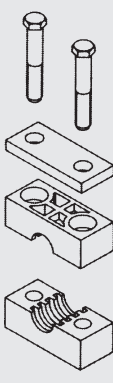
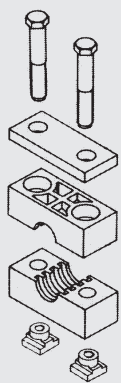
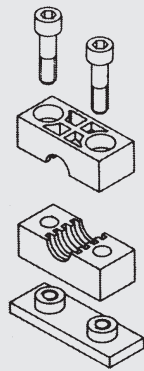
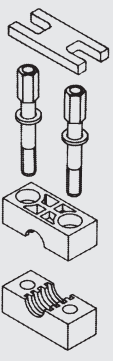
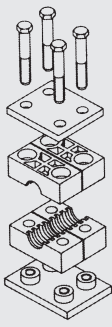
Model A Size 1–10	Model AV Size 1–10	Model A1 Size 1–10	Model A1TM Size 1–4
			
Model B Size 1–7	<p>Notice: No washers are required in the AL version for series B.</p>		
			
Model D Size 1–7			
			
Model G Size 1–10			
			

Dimensions for heavy range DIN 3015 Part 2

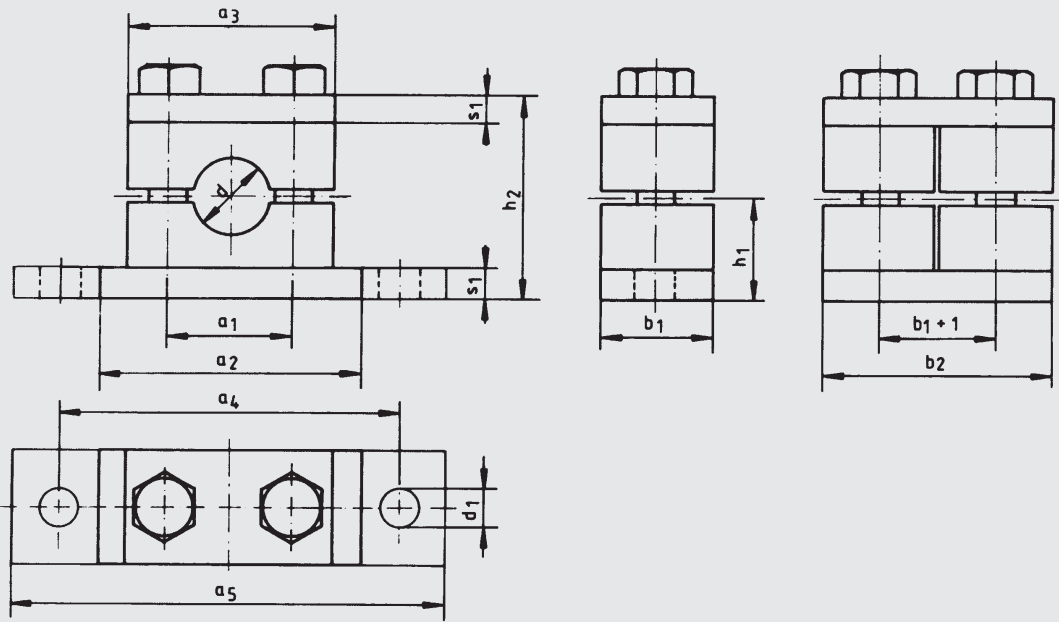

Size	Dimensions [mm]												Hex. head	Hex. socket
	a1	a2	a3 PA, PP	a3 AL	a4	a5	b1	b2	h1	h2	s1	s2	ISO 4014	ISO 4762
1	33	73	55	57	85	113	30	60	24	48	8	11	M10 x 45	M10 x 25
2	45	85	70	70	97	125	30	60	32	64	8	11	M10 x 60	M10 x 40
3	60	100	85	85	112	140	30	60	38	76	8	11	M10 x 70	M10 x 50
4	90.5	140	115	119	160	190	45	90	54.5	109	10	14	M12 x 100	M12 x 80
5	122	180	152	160	205	240	60	120	70	140	10	18	M16 x 130	M16 x 110
6	168	225	205	215	270	310	80	160	100	200	15	22	M20 x 190	M20 x 150
7	205	270	252	258	320	370	90	180	115	230	15	26	M24 x 220	M24 x 180
8	265	340	320	323	-	-	120	240	160	320	25	-	M30 x 300	-
9	395	520	466	475	-	-	160	324	235	470	30	-	M30 x 450	-
10	530	680	630	630	-	-	180	364	295	590	30	-	M30 x 560	-

Individual parts for heavy range DIN 3015 Part 2

Pair of clamp jaws, ribbed (HRS...KP...)

Size 1 - 10

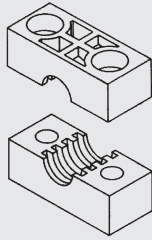

Pair of clamp jaws, smooth (HRGS...KP...)

Size 1 - 10

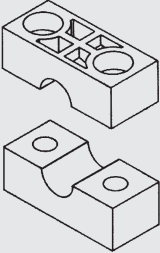

Model code

(also order example)

HRS 3 KP 23 PP

Range

HRS = HY-ROS clamp, heavy range with ribbed internal surface
HRGS = HY-ROS clamp, heavy range with smooth internal surface

Size

(as per dimensions)

Designation

KP = pair of clamp jaws

Pipe diameter

Material of clamp jaws

PP = polypropylene
PA = polyamide
PAFF = polyamide, flame-retardant to EN 45545-2 R22, R23, HL3
TPE = thermoplastic elastomer
AL = aluminium (not for HRGS)

Cover plate (DP)

Size 1 - 10

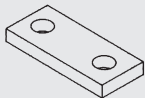

Double cover plate (DDP)

Size 1 - 10

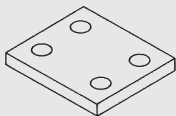

Locking plate (SIP)

Size 1 - 7

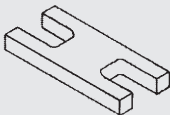

Model code

(also order example)

HRS 2 DP ST BL

Range

HRS = HY-ROS heavy range

Size

(as per dimensions)

Designation

DP = cover plate
DDP = double cover plate
SIP = locking plate (only up to size 7)

Material of steel parts

ST = steel
A2 = stainless steel (on request)
A4 = stainless steel (on request)

Plating of steel parts

BL = unplated
ZN = zinc-plated (only up to size 7)

Weld plate (AP)

Size 1 - 10

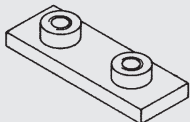

Extended weld plate (APV)

Size 1 - 10

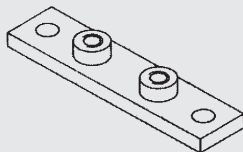

Double weld plate (DAP)

Size 1 - 10

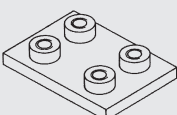

Model code

(also order example)

HRS 2 APV ST M BL

Range

HRS = HY-ROS heavy range

Size

(as per dimensions)

Designation

AP = weld plate
APV = extended weld plate
DAP = double weld plate

Material of steel parts

ST = steel
A2 = stainless steel (on request)
A4 = stainless steel (on request)

Thread type

M = metric thread

Plating of steel parts

BL = unplated
ZN = zinc-plated

Bolts

Hex. head bolt ISO 4014
HRS size 1 -10



Hex. socket bolt ISO 4762
HRS size 1 -7



Build-up bolt (AF)



Dimensions

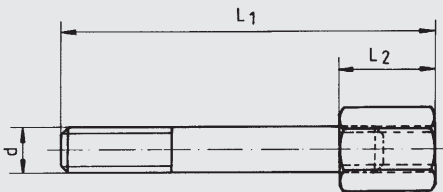

Size	Dimensions [mm]			d
	L1	L2		
1	50	25		M10
2	65	25		M10
3	75	25		M10
4	106	26		M12
5*	145	35		M16
6*	200	50		M20
7*	236	56		M24

* without washer

Model code

(also order example)

6kt-shr.ISO4014 - M10 x 70 - 8.8 A3B

Range

6kt-shr.ISO4014 = hex. head bolt to ISO 4014
Zyl-shr.ISO4762 = hex. socket bolt to ISO 4762

Size

ISO4014	ISO4762*	for HRS size
M10 x 45	M10 x 25	1
M10 x 60	M10 x 40	2
M10 x 70	M10 x 50	3
M12 x 100	M12 x 80	4
M16 x 130	M16 x 110	5
M20 x 190	M20 x 150	6
M24 x 220	M24 x 180	7
M30 x 300		8
M30 x 450		9
M30 x 560		10

* only AL version

Bolt quality

8.8 = to ISO 4014, ISO 4762

Bolt plating

no details = unplated
A3B = zinc-plated

Model code

(also order example)

HRS 5 AF16 ST M ZN

Range

HRS = HY-ROS heavy range

Size

(as per dimensions)

Designation

AF10 = build-up bolt M10
AF12 = build-up bolt M12
AF16 = build-up bolt M16
AF20 = build-up bolt M20
AF24 = build-up bolt M24

Material of steel parts

ST = steel
A2 = stainless steel (on request)
A4 = stainless steel (on request)

Thread type

M = metric thread

Plating of steel parts

BL = unplated
ZN = zinc-plated

C mounting rail (TS)

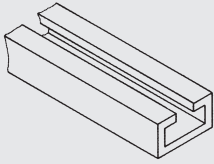

Dimensions

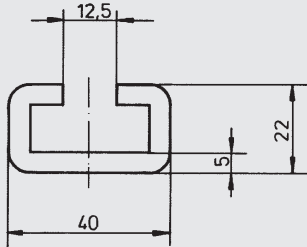

Notice:
available in 1 m and 2 m pieces

Model code (also order example)

HRS TS40x22 ST BL 2m

Range

HRS = HY-ROS heavy range

Model

TS40x22 = C mounting rail 40x22

Material of steel parts

ST = steel
A2 = stainless steel (on request)
A4 = stainless steel (on request)

Plating of steel parts

BL = unplated
ZN = zinc-plated

Length

1 m
2 m
Other lengths on request

Mounting rail nut (TM)

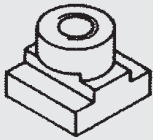

Dimensions

Mounting rail nut TM10

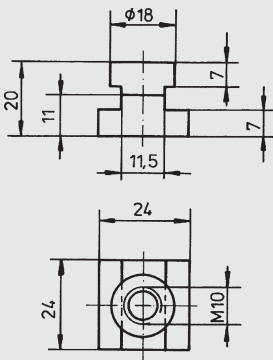

Mounting rail nut TM12

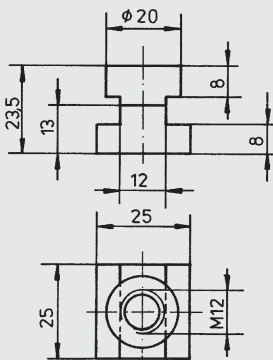

Model code (also order example)

HRS TM10 ST M ZN

Range

HRS = HY-ROS heavy range

Designation

TM10 = mounting rail nut size M10
TM12 = mounting rail nut size M12

Material of steel parts

ST = steel
A2 = stainless steel (on request)
A4 = stainless steel (on request)

Thread type

M = metric thread

Plating of steel parts

ZN = zinc-plated
Others on request

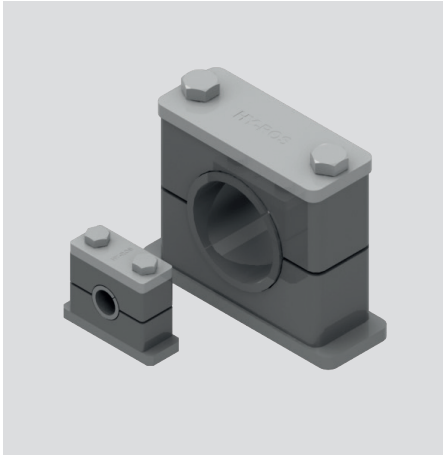

Heavy range with elastomer insert to DIN 3015 Part 2

HRES, HRERS

Size	d internal surface smooth [mm]	d internal surface ribbed [mm]
	2	6
8		-
10		10
12		12
12.7		-
14		14
15		15
16		16
17.2		17.2
18		-
19	-	
3	20	20
	21.3	-
	22	22
	23	-
	25	25
	26.9	-
	28	28
	30	30
32	-	
4	33.7	-
	35	-
	38	38
	40	-
	42	42
	45.5	44.5
	48	48
	51	-
	53.4	-
56.4	57	
5	60	-
	65	-
	70	-
	73	-
	76	76
6	83	-
	89	89
	94	-
	101	-
7	108	108
	114	-
	133	-
	140	-

Model code (also order example)

HRES 2 A 16 PP ST M BL

Range

HRES = HY-ROS clamp, heavy range,
elastomer insert with smooth internal surface
HRERS = HY-ROS clamp, heavy range,
elastomer insert with ribbed internal surface

Size

2 = size 2
3 = size 3
4 = size 4
5 = size 5
6 = size 6
7 = size 7

Model for complete clamps

(pair of clamp jaws not mentioned)
A = with elastomer insert, weld plate,
cover plate and hex. head bolt

Pipe diameter

Material of clamp jaws

PP = polypropylene
PA = polyamide
PAFF = polyamide, flame-retardant to EN 45545-2 R22, R23, HL3

Material of steel parts

ST = steel
A2 = stainless steel (on request)
A4 = stainless steel (on request)

Thread type

M = metric thread

Plating of steel parts

BL = weld plate unplated, cover plate zinc-plated, bolts unplated
BL/ZN = weld plate unplated, cover plate zinc-plated, bolts zinc-plated
ZN = weld plate zinc-plated, cover plate zinc-plated, bolts zinc-plated

Model A
Size 2-7

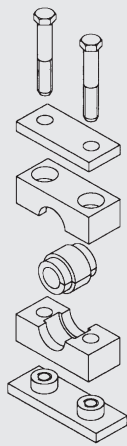

Dimensions

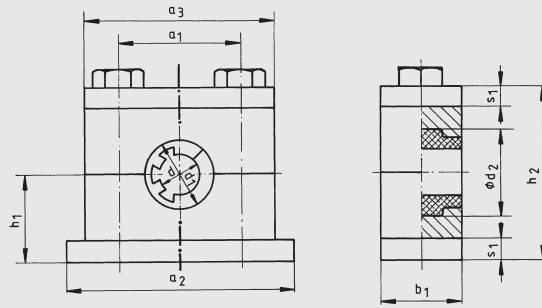

Size	Dimensions [mm]									Hex. head ISO 4014
	d1	d2	b1	h1	h2	a1	a2	a3	s1	
2	25.5	31	30	31	62	45	85	70	8	M10 x 60
3	39	46	30	37	74	60	100	85	8	M10 x 70
4	65	74	45	53.5	107	90.5	140	115	10	M12 x 100
5	89	98	60	68.5	137	122	180	152	10	M16 x 130
6	116	132	80	98.5	197	168	225	205	15	M20 x 190
7	154	168	90	113.5	227	205	270	252	15	M24 x 220

Individual parts

Pair of clamp jaws (KP)
Size 2 - 7

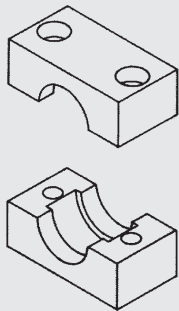

Model code

(also order example)

HRES 4 KP PP

Range

HRES = HY-ROS clamp, heavy range, with elastomer insert

Size

- 2 = size 2
- 3 = size 3
- 4 = size 4
- 5 = size 5
- 6 = size 6
- 7 = size 7

Designation

KP = pair of clamp jaws

Material of clamp jaws

- PP = polypropylene
- PA = polyamide
- PAFF = polyamide, flame-retardant to EN 45545-2 R22, R23, HL3

Elastomer insert smooth (HRES...EE...)

Size 2/4L, 3/6L, 4, 5, 6, 7

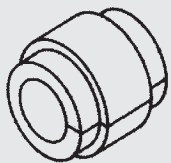

Elastomer insert ribbed (HRERS...EE...)

Size 2/4L, 3/6L, 4, 5, 6, 7

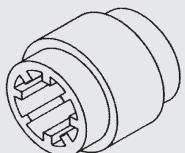

Model code

(also order example)

HRES 2/4L EE 16 TPE

Range

- HRES = elastomer insert, internal surface smooth
- HRERS = elastomer insert, internal surface ribbed

Size

- 2/4L = size 2 (HRS), size 4 (HRL)
- 3/6L = size 3 (HRS), size 6 (HRL)
- 4 = size 4
- 5 = size 5
- 6 = size 6
- 7 = size 7

Designation

EE = elastomer insert

Pipe diameter

(as per dimensions)

Insert material

- TPE = thermoplastic elastomer
- NBR* = acrylonitrile butadiene elastomer

* only sizes 5 - 7

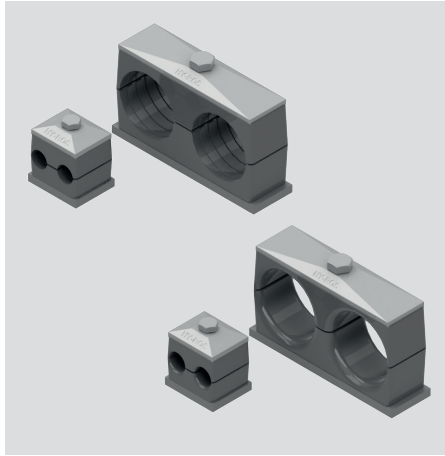

Twin clamps to DIN 3015 Part 3

HRZ, HRGZ

Size	Pipe outside Ø [mm]
1	6
	6.4
	8
	9.5
	10
	12
2	12.7
	13.7
	14
	15
	16
	17.1
3	18
	19
	20
	21.3
	22
	23
4	25
	25.4
	26.9
	28
5	30
	32
	33.7
	35
	38
	40
	42

Model code

(also order example)

HRZ 2 A 16-16 PP ST M BL

Range

HRZ = HY-ROS twin clamp with ribbed internal surface
HRGZ = HY-ROS twin clamp with smooth internal surface

Size

1 = size 1
2 = size 2
up to size 5

Model for complete clamps

(pair of clamp jaws not mentioned)

A = with weld plate, cover plate and hex. head bolt
A1 = with cover plate and hex. head bolt
A1TM = with cover plate, hex. head bolt and mounting rail nut
D = with build-up bolt and locking plate

Pipe diameter

(specification of each Ø as per pipe outside Ø)

Material of clamp jaws

PP = polypropylene
PA = polyamide
PAFF = polyamide, flame-retardant to EN 45545-2 R22, R23, HL3
TPE = thermoplastic elastomer

Material of steel parts

ST = steel
A2 = stainless steel (on request)
A4 = stainless steel (on request)

Thread type

M = metric thread

Plating of steel parts

BL = weld plate unplated, cover plate zinc-plated, bolts zinc-plated (only model A)
ZN = weld plate zinc-plated, cover plate zinc-plated, bolts zinc-plated

Models for twin clamps to DIN 3015 Part 3

Model A
Size 1 - 5

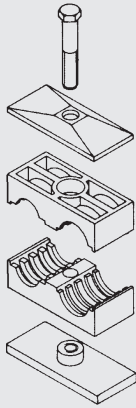

Model A1
Size 1 - 5

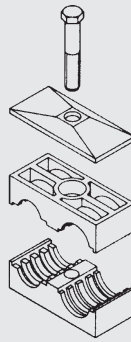

Model A1TM
Size 1 - 5

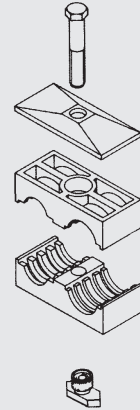

Model D
Size 1 - 5

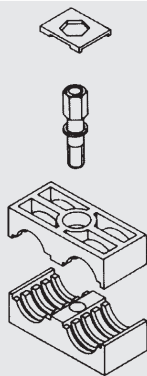

Dimensions

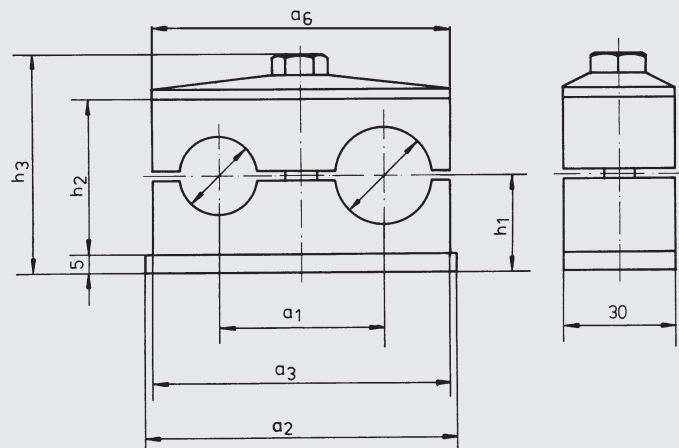

Size	Dimensions [mm]							Hex. head bolt ISO 4014
	a1	a2	a3	a6	h1	h2	h3	
1	20	37	36	34	18.5	27	43	M6 x 35
2	29	55	53	51	18	26	43.5	M8 x 35
3	36	70	67	64	23.5	37	54.5	M8 x 45
4	45	85	82	78	26	42	59.5	M8 x 50
5	56	110	106	102	32	54	71.5	M8 x 60

Individual parts for twin clamps DIN 3015 Part 3

Pair of clamp jaws, ribbed (HRZ...KP...)

Size 1 - 5

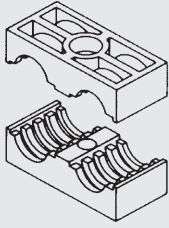

Pair of clamp jaws, smooth (HRGZ...KP...)

Size 1 - 5

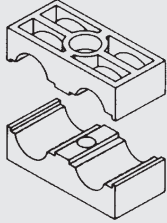

Cover plate (DP)

Size 1 - 5

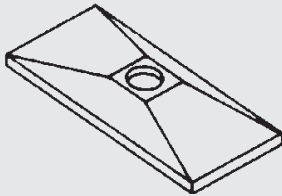

Weld plate (AP)

Size 1 - 5

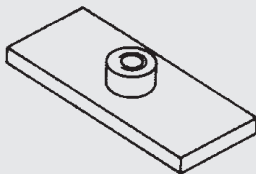

Model code

(also order example)

HRZ 3 KP 23-23 PP

Range

HRZ = HY-ROS twin clamp with ribbed internal surface
HRGZ = HY-ROS twin clamp with smooth internal surface

Size

1 = size 1
2 = size 2
up to size 5

Designation

KP = pair of clamp jaws

Pipe diameter

(specification of each \varnothing as per pipe outside \varnothing)

Material of clamp jaws

PP = polypropylene
PA = polyamide
PAFF = polyamide, flame-retardant to EN 45545-2 R22, R23, HL3
TPE = thermoplastic elastomer
Others on request

Model code

(also order example)

HRZ 3 DP ST BL

Range

HRZ = HY-ROS twin clamp

Size

(as per dimensions)

Designation

DP = cover plate

Material of steel parts

ST = steel
A2 = stainless steel (on request)
A4 = stainless steel (on request)

Plating of steel parts

BL = unplated
Others on request

Model code

(also order example)

HRZ 2 AP ST M BL

Range

HRZ = HY-ROS twin clamp

Size

(as per dimensions)

Designation

AP = weld plate

Material of steel parts

ST = steel
A2 = stainless steel (on request)
A4 = stainless steel (on request)

Thread type

M = metric thread

Plating of steel parts

BL = unplated
Others on request

Interconnecting weld plate (RAP)*

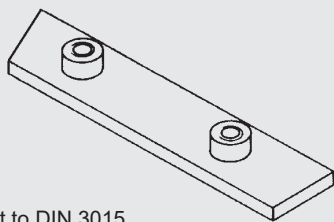

*not to DIN 3015

Dimensions

Size	Number of clamps	Dimensions [mm]			
		L1	L2	L	d
1	5	18	40	196	M6
2	5	28	58	288	M8
3	5	35	72	358	M8
4	5	43	90	446	M8
5	5	55	112	558	M8

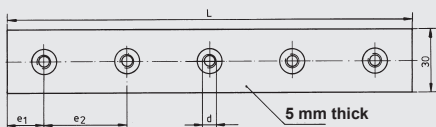

Locking plate (SIP)



Dimensions

Size 1

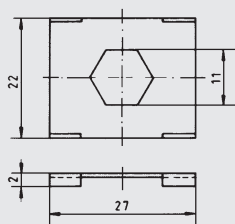

Size 2 - 5

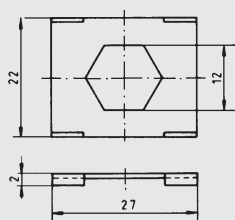

Model code

(also order example)

HRZ 2 RAP ST M BL

Range

HRZ = HY-ROS twin clamp

Size

(as per dimensions)

Designation

RAP = interconnecting weld plate

Material of steel parts

ST = steel

A2 = stainless steel (on request)

A4 = stainless steel (on request)

Thread type

M = metric thread

Plating of steel parts

BL = unplated

Others on request

Model code

(also order example)

HRZ 2-5 SIP ST ZN

Range

HRZ = HY-ROS twin clamp

Size

1 = size 1

2-5 = size 2-5

Designation

SIP = locking plate

Material of steel parts

ST = steel

A2 = stainless steel (on request)

A4 = stainless steel (on request)

Plating of steel parts

ZN = zinc-plated

Others on request

C mounting rail (TS)

C mounting rail TS

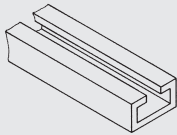

C mounting rail with weld struts
TS28x11AS

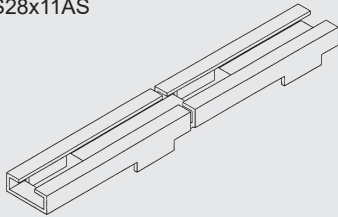

Dimensions

C mounting rail TS
available in 1 m and 2 m pieces

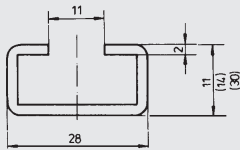

C mounting rail with weld struts
available in 1 m pieces

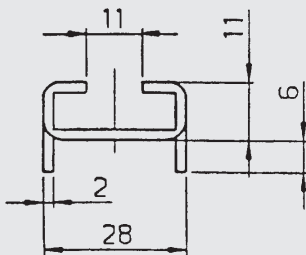

Mounting rail nut (TM)

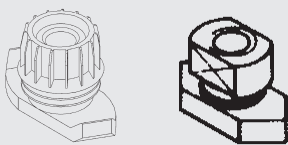

Dimensions

Size 1 (TMV6)

Size 2 - 5 (TM8)

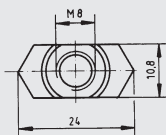
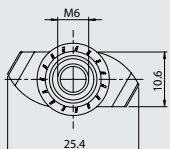
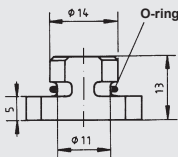
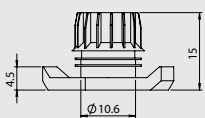

Model code

(also order example)

HRL TS28x11 ST BL 1m

Range

HRL = HY-ROS light range

Model

TS28x11 = C mounting rail 28x11
 TS28x14 = C mounting rail 28x14
 TS28x30 = C mounting rail 28x30
 TS28x11AS = C mounting rail with weld struts 28x11

Material of steel parts

ST = steel
 AL = aluminium (on request)
 A2 = stainless steel (on request)
 A4 = stainless steel (on request)

Plating of steel parts

BL = unplated
 ZN = zinc-plated
 Others on request

Length

1 m
 2 m (not for C mounting rail with weld struts)
 Other lengths on request

Model code

(also order example)

HRL TMV6 ST ZN

Range

HRL = HY-ROS light range, for size 1
 HRZ = HY-ROS twin clamp, from size 2

Designation

TMV6 = mounting rail nut with anti-twist protection, M6 (only size 1)
 TM6 = mounting rail nut without anti-twist protection, M6 (only size 1)
 TM8 = mounting rail nut M8 (from size 2)

Material of steel parts

ST = steel
 A4 = stainless steel (on request)

Plating of steel parts

ZN = zinc-plated
 Others on request

Bolts

Hex. head bolt ISO 4014
HRZ size 1 - 5



Model code

(also order example)

6kt-shr.ISO4014 - M6 x 35 - 8.8 A3B

Range

6kt-shr.ISO4014 = hex. head bolt to ISO 4014

Size

ISO4014	for HRZ size
M6 x 35	1
M8 x 35	2
M8 x 45	3
M8 x 50	4
M8 x 60	5

Bolt quality

8.8 = to ISO 4014

Bolt plating

no details = unplated
A3B = zinc-plated

Build-up bolt (AF)

HRZ size 1 - 5



Dimensions

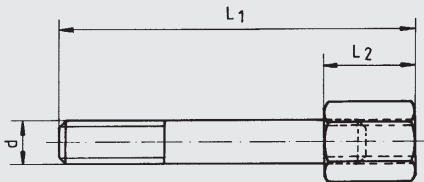

Size	Dimensions [mm]		
	L1	L2	d
1	34	14	M6
2	33	13	M8
3	44	15	M8
4	49	15	M8
5	62	15	M8

Model code

(also order example)

HRZ 4 AF ST M ZN

Range

HRL = HY-ROS light range, for size 1
HRZ = HY-ROS twin clamp, from size 2

Size

	for HRZ size
0+1	1
2	2
up to size 5	

Designation

AF = build-up bolt

Material of steel parts

ST = steel
A2 = stainless steel (on request)
A4 = stainless steel (on request)

Thread type

M = metric thread

Plating of steel parts

ZN = zinc-plated
Others on request

NOTE

The information in this brochure relates to the operating conditions and applications described. For applications and operating conditions not described, please contact the relevant technical department.

The operator is always responsible for determining the product suitability for the specific application. Quantified values for product characteristics are average values for a new product that undergo a time deterioration process.

Subject to technical modifications and errors.

HYDAC Accessories GmbH

Hirschbachstr. 2

66280 Sulzbach/Saar

Tel.: +49 (0)6897 - 509-01

Fax: +49 (0)6897 - 509-1009

Internet: www.hydac.com

E-mail: accessories@hydac.com